

Cafitesse Quantum 110

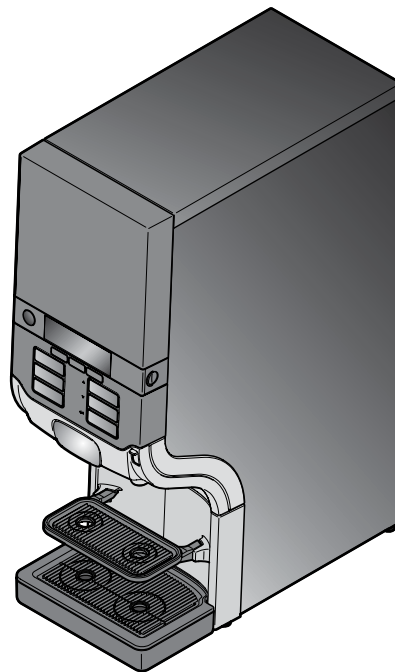

Operator manual

Copyright 2016 © JACOBS DOUWE EGBERTS, Netherlands

The English version is the original version of the operator manual.
Other languages are translations of the original operator manual.

Manufacturer:
N&W Global Vending SpA
Via Roma 24
24030 Valbrembo (BG)
Italy

TABLE OF CONTENTS

1 Introduction	4	6 Programming the dispenser.....	25
About the dispenser	4	Starting the operator mode.....	25
About this operator manual	4	Menu navigation	26
2 Safety instructions	5	Counter readings /	
General.....	5	resettable counter readings.....	27
Installation	6	Set resettable counters to zero ...	29
Transport, storage and operation ..	7	Changing cup volumes.....	30
Servicing the dispenser	7	Changing drink strength	31
Food safety instructions (HACCP) 8		Setting date and time	32
3 Components of the dispenser..	11	Setting the cleaning days	33
Front of the dispenser	11	ECO settings	35
Rear of the dispenser	11	Setting telephone numbers	37
Icons on the display.....	12	7 Display messages and trouble	
4 Operating the dispenser	13	shooting	39
Place cups and pots correctly	13	8 Technical specification	42
Drink delivery.....	13	9 Options	44
Portioned or continuous drink		Software options.....	44
delivery	14	Hardware accessories	44
Drink delivery with preselections .	15	10 Index	46
Inserting and removing product		Cleaning procedure.....	47
packs	17		
Switching on the dispenser	19		
Switching off the dispenser	19		
Locking/unlocking the dispenser .	20		
5 Cleaning the dispenser.....	21		
Cleaning procedures	21		
Clean & Flush	21		
Flush.....	23		
Manual daily cleaning.....	24		

1 INTRODUCTION

About the dispenser

The Cafitesse Quantum 110 is a dispenser for the delivery of coffee, tea and only hot water in commercial sectors.

The dispenser functions using special disposable product packs. These patented „Bag-in-Box“ (BIB) product packs contain high quality liquid drink concentrate for drink production. The dispenser can hold one product pack.

The drinks can be dispensed into cups and pots of various sizes.

Optionally you can request your Cafitesse system supplier to equip your dispenser

- with a payment system for drink vending (see „Options“)
- with a height extension foot for the delivery into larger pots and airpots (see „Options“)
- with a one line cold water valve for the delivery of cold water (see „Options“)
- with a two line cold water valve for the delivery of cold drinks and cold water (see „Options“)
- with a door lock to prevent unauthorized access to the dispenser.

- with a USB release key for a temporary drink delivery, when the dispenser is in blocked mode.

Please note, that the options listed above may not apply in each country.

About this operator manual

This operator manual describes the main applications and functions of the dispenser. Before starting to use the dispenser, please read this operator manual to ensure that you have understood the operation of the machine and the safety instructions.

You will find the following symbols throughout this operator manual, please pay attention to them:



Note:

Additional information which may be helpful during the dispenser operation.



Caution:

Information to which you should pay careful attention in order to ensure food safety, to prevent personal injury or damage to the dispenser.



Warning:

Dangers that can result in severe personal injury, death and/or severe damage to the dispenser.



Danger:

DANGERS THAT WILL RESULT IN SEVERE PERSONAL INJURY OR DEATH.

2 SAFETY INSTRUCTIONS

General

Please read the instructions in this operator manual carefully before using, cleaning or moving the dispenser. Ensure that you and all other persons who operate, clean or move the dispenser are familiar with, and act according to the safety and hygiene aspects of the dispenser.

You may only use the dispenser according to the instructions in this operator manual for the delivery of drinks. The manufacturer is not liable for any damage or injury resulting from improper use of the dispenser or from non-compliance with the procedures described in this operator manual.

- The installation, servicing, repair and programming of the machine may only be carried out by an authorised and appropriately trained service technician assigned by your Cafitesse system supplier.
- Only use original spare parts for the operation of the dispenser.
- The operation, filling and cleaning of the dispenser may only be carried out by authorised and trained personnel.

- The dispenser is not suitable for outdoor use.
- The dispenser must be installed where it can be supervised by trained personnel.



Warning:

**The liquids delivered by the dispenser are hot!
Avoid scalding!
Keep hands and other body parts away from the dispenser while drinks are being dispensed and during the rinsing program.**



Warning:

Do not place cups, pots, or containers filled with hot liquids on top of the dispenser. There is the risk of being scalded, in case the cups/pots/containers fall down.



Warning:

Keep sufficient space around the dispenser to get away easily in case of hot liquid splashes.



Warning:

This dispenser is not intended for use by persons (including children) with limited physical, sensory and mental faculties, or persons with insufficient experience and/or knowledge of the dispenser.

This does not apply if they are supervised by a person responsible for their safety or have received instructions on how to use the dispenser. Children should be supervised to ensure that they do not play with the dispenser.



Warning:

Place the dispenser on a table or counter with a minimum height of 60 cm/24 in to avoid that young children can press a drink button.



Caution:

Check and empty the drip tray of the dispenser regularly to avoid the risk of being scalded and to avoid a wet floor (slip danger) when (hot) liquids spill out of the drip tray.

I 2 SAFETY INSTRUCTIONS

Installation

The installation and programming of the dispenser may only be carried out by authorised and appropriately trained service technicians assigned by your Cafitesse system supplier.

The dispenser is designed for installation indoors on a stable surface such as a table or counter.

- When setting up the dispenser, ensure there is a clearance of approximately 5 cm / 2 in between the dispenser and the wall.
- Protect the dispenser against frost, rain and direct sunlight.
- Protect the dispenser against running water, splashes, spray or steam, heat and heavy dust.



Warning:

The dispenser may not be cleaned using a water jet and is not suitable for installation on a surface where a water jet may be used in the vicinity (e.g. for cleaning purposes).

- Ensure that there is sufficient space around the dispenser for ventilation.
- Keep the front and rear of the dispenser accessible for cleaning and servicing.
- Connect the dispenser to the drinking water supply in compliance with local regulations.



Caution:

Only hose sets as per EN 61770 may be used to connect the water supply.



Caution:

If you intend to use the dispenser to deliver cold drinks, please check the drinking water quality beforehand to ensure that you obtain cold drinks that pose no health risks.

- Connect the dispenser according to local regulations to a secured electric circuit.

If you connect the dispenser to a plug in the wall, then:

- Use a grounded safety socket in compliance with local regulations.
- Ensure that the electric circuit is protected by a residual current device.
- Ensure that the plug remains accessible after installation.



Warning:

Never touch the power source or plug if your hands, the power cord or socket are wet.

If you connect the dispenser to a permanently wired power source (without mains plug), then ensure that the electric circuit is equipped with a circuit breaker with a contact gap of minimum 3 mm / 0.12 in that controls all poles.

Transport, storage and operation

Always store and transport the dispenser in the original packaging. Before storing or transporting the dispenser:

- Place the product packs in the refrigerator.
- Clean the dispenser.
- Contact your Cafitesse system supplier so that an authorised and trained service technician can drain the water from the boiler and protect the dispenser against frost damage.



Warning:

The dispenser may not be subject to frost during operation, storage or transport.

If you suspect there is frost damage following storage or transport, contact your Cafitesse system supplier to have the dispenser checked and a function test implemented.

Servicing the dispenser

The servicing, repair and programming of the dispenser may only be carried out by authorised and appropriately trained service technicians assigned by your Cafitesse system supplier.



Warning:

If the mains cable of the dispenser is damaged, switch the dispenser off and contact your Cafitesse system supplier to have the mains cable replaced.

I 2 SAFETY INSTRUCTIONS

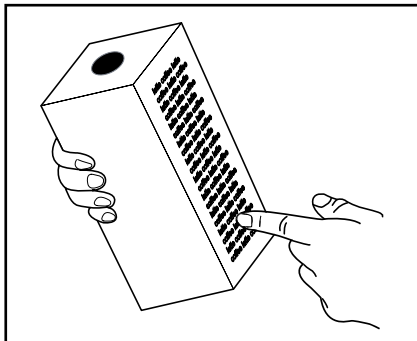

Fig. 1

Food safety instructions (HACCP)

As the operator of the dispenser, you are responsible for its safe and hygienic operation. Please comply therefore with the following instructions in order to meet the food safety standards.

Storage of product packs

- Store the product packs according to the description on the packaging (fig. 1).
- Please note the „Best before“ date printed on the packaging (fig. 2).

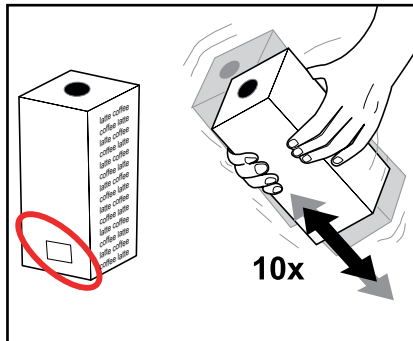

Fig. 2

- Always use the product packs according to the „first in -first out“ principle (product packs stored first must be used first).
- Do not use a product pack if the „Best before“ date has expired.

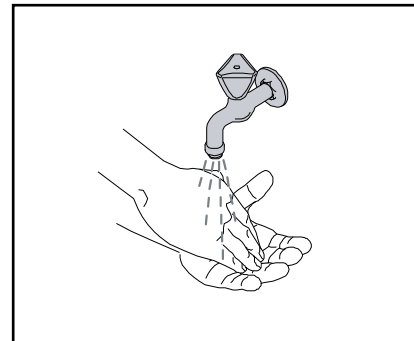

Fig. 3

Handling the product packs

1. Wash your hands before touching a product pack (fig. 3).
2. Shake the product pack at least 10 times before inserting it in the dispenser (fig. 2).
3. Read the instructions on the rear of the pack.
4. Check the product pack for any damage. Never use a damaged product pack.
5. Check the „Best before“ date on the label of the product pack. Do not use a product pack if the „Best before“ date has expired.

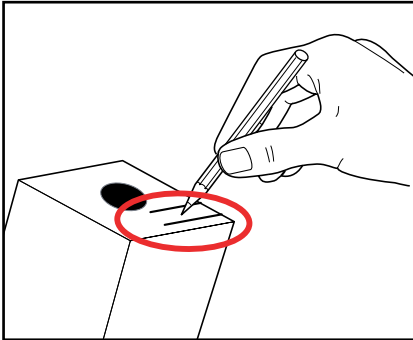

Fig. 4

6. Follow the instructions on the product pack. Write at least the expiry date on the product pack (fig. 4).

**Note:**

When the product pack is open, ensure that no liquid spills out onto clothing, the floor or other equipment.

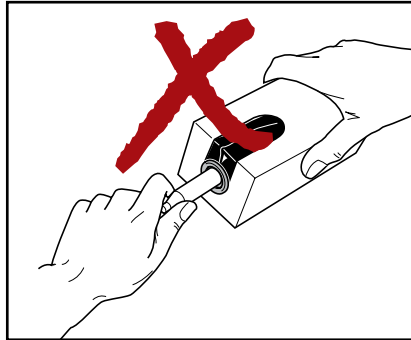

Fig. 5

**Caution:**

Do not touch the tip of the doser with your hands or the cleaning cloth. If the doser needs cleaning, rinse with clear water only (fig. 5).

If you do not use the dispenser for a longer period (e.g. during a company holiday), follow the instructions in the chapter „Switching the dispenser on/off“.

I 2 SAFETY INSTRUCTIONS

Cleaning the dispenser

Clean the dispenser regularly

1. Clean the surface around the dispenser.
2. Wash your hands before touching the dispenser or a product pack.
3. Clean the dispenser according to the instructions in the operator manual (see chapter „Cleaning the dispenser“).
4. During cleaning, check the „Best before“ and „Expiry“ dates on the product pack in the dispenser. If the „Best before“ or „Expiry“ date is expired, replace the product pack.
5. Schedule cleaning activities and record them.



Caution:

Clean all dispenser parts that come into contact with the product with a cleaning agent. Only use cleaning agents recommended by the food industry and your Cafitesse system supplier. For safe handling, dosing and use of cleaning agents, follow the instructions on the label of the cleaning agent.



Danger:

DO NOT SPRAY OR SPLASH THE DISPENSER WITH WATER. DO NOT USE A WATER JET FOR CLEANING. NEVER IMMERSE THE DISPENSER IN WATER.



Danger:

NEVER TILT THE DISPENSER TO CLEAN BEHIND OR BELOW IT. AVOID SCALDING! THE BOILER CONTAINS VERY HOT WATER THAT CAN SPILL OUT IF YOU TILT OR MOVE THE DISPENSER.

Training

Train new staff regarding food safety instructions (HACCP).

- Inform new staff about schedules and cleaning procedures.
- Ensure that new staff reads the operator manual before operating the dispenser. Keep the operator manual close to the dispenser.

If there are any other questions, please contact your Cafitesse system supplier.

3 COMPONENTS OF THE DISPENSER

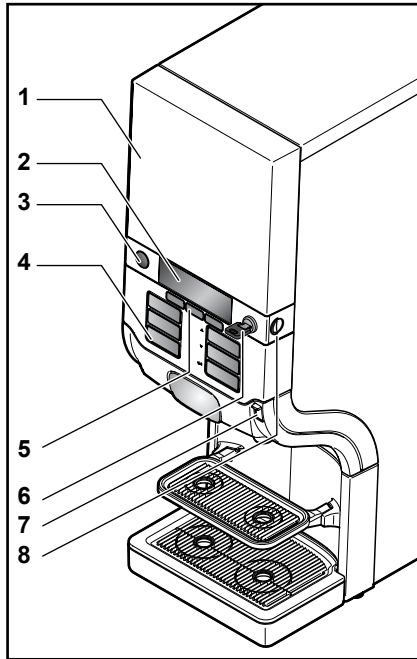

Fig. 6

Front of the dispenser:

- 1 - Dispenser door
- 2 - Display
- 3 - STOP-button
- 4 - Drink buttons
- 5 - Preselection buttons
- 6 - Door lock with key (option)

2016 - 02

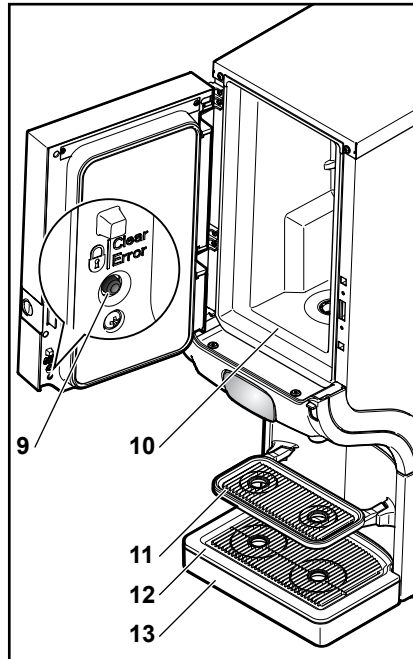

Fig. 7

- 7 - Port for USB key
- 8 - Door release button
- 9 - **LOCK**/Clear-Error switch
- 10- Cooling compartment
- 11- Cup tray
- 12- Drip grid
- 13- Drip tray

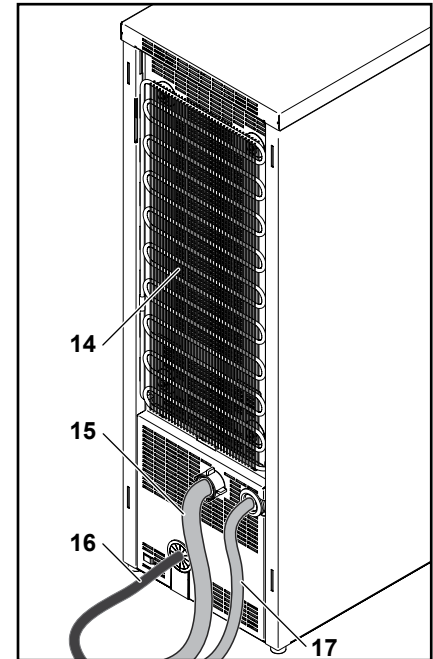

Fig. 8

Rear of the dispenser:

- 14- Condensate grid
- 15- Water supply hose
- 16- Power cord
- 17- Water supply hose for cold drinks/
cold water (option)

I 3 COMPONENTS OF THE DISPENSER

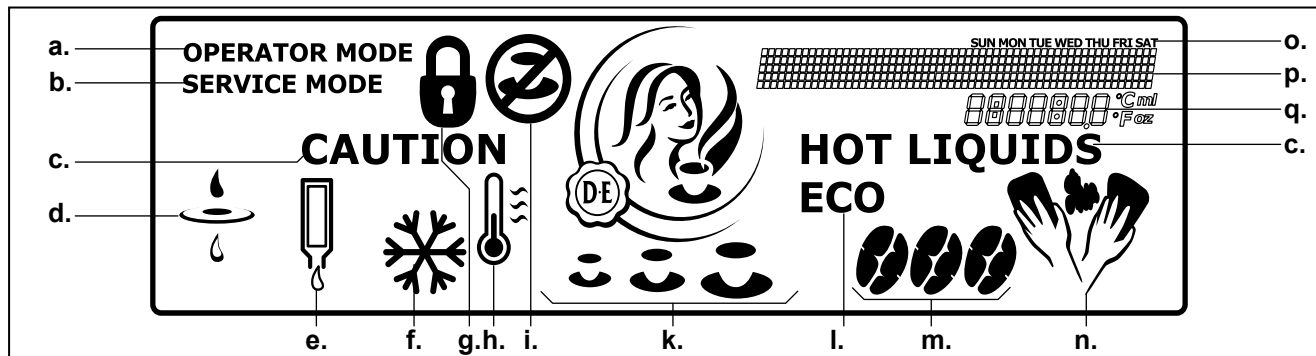

Fig. 9

Icons on the display:

- a. **OPERATOR MODE**
the USB operator stick is inserted and the operator mode is active
- b. **SERVICE MODE**
the service mode is active
- c. **CAUTION HOT LIQUIDS**
the dispenser delivers hot water or hot drinks or
the dispenser is flushed
- d. **FILTER**
replace the water filter
- e. **PRODUCT PACK**
insert a full product pack
- f. **ICED**-preselection (option)
dispense a drink as cold drink
- g. **LOCK**
the dispenser is locked and cannot dispense drinks
- h. **TEMPERATURE**
water temperature in the boiler is too low and the dispenser is heating up
- i. **DELIVERY BLOCKED**
the dispenser cannot deliver the selected drink
- j. **VOLUME**-preselection
select a small, medium, or large drink
- k. **ECO**
the energy saving mode is active
- l. **STRENGTH**-preselection
select a mild, normal or strong drink
- m. **CLEANING**
clean the dispenser
- n. **WEEKDAYS**
- o. **MESSAGE**-line
Messages are displayed to guide you through the programming steps, or in case of errors
- p. **INFO**-field
display of cooling compartment temperature, time, etc.

4 OPERATING THE DISPENSER

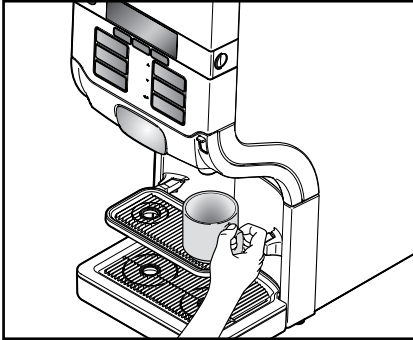

Fig. 10

Place cups and pots correctly

The dispenser has two product outlets:

- Left: for coffee and tea
- Right: for hot water



Caution:

Place your cup or pot under the outlet below the drink button of your selection.

- Place your cup on the cup tray (fig. 10).
- Tilt the cup tray upwards to provide enough room for a pot (fig. 11).
- Place the pot on the drip tray (fig. 12).

A special dispenser foot may be required for larger pots.

2016 - 02

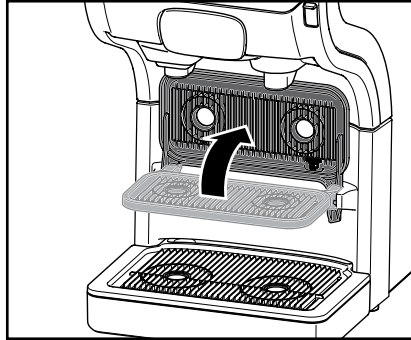

Fig. 11

Drink delivery

Warning:

The liquids dispensed by the dispenser are hot!

Avoid scalding!

Keep hands and other body parts away from the dispenser while drinks are being delivered.

Never leave children unsupervised near the dispenser.



Fig. 12

To deliver a drink:

1. Place your cup on the cup tray (fig. 10).
2. Press the drink button of your choice. The drink will be delivered via the corresponding outlet.
3. Press the STOP button if you want to interrupt or cancel the drink delivery.

I 4 OPERATING THE DISPENSER

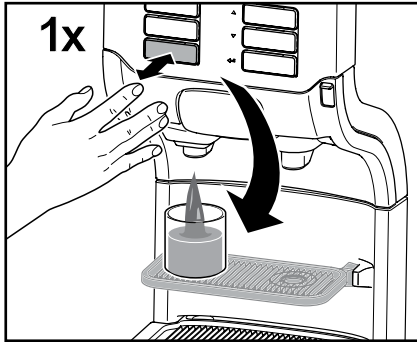

Fig. 13

Portioned or continuous drink delivery

During installation, the service technician programs the dispenser to operate with one of the following delivery options.

- **Portioned delivery:**

The drink button only needs to be pressed once (fig. 13).

The dispenser stops automatically after one portion is delivered. (The respective portion volumes can be programmed by the service technician).

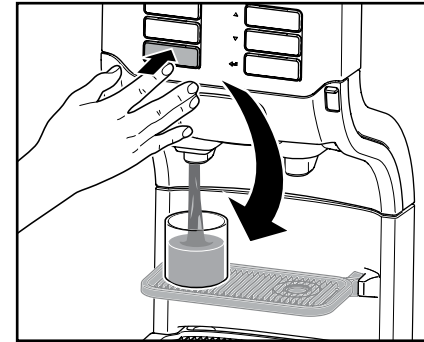

Fig. 14



Caution:

Press the STOP button if the cup or pot is too small for the delivered drink volume and when there is the risk of scalding by spilling of hot liquids.

- **Continuous delivery:**

The drink button must be kept pressed until the cup or pot is full (fig. 14). The dispenser stops when you release the drink button.



Note:

We recommend portioned delivery with fixed cup sizes in selfservice areas where customers may not be familiar with the operation of the dispenser.

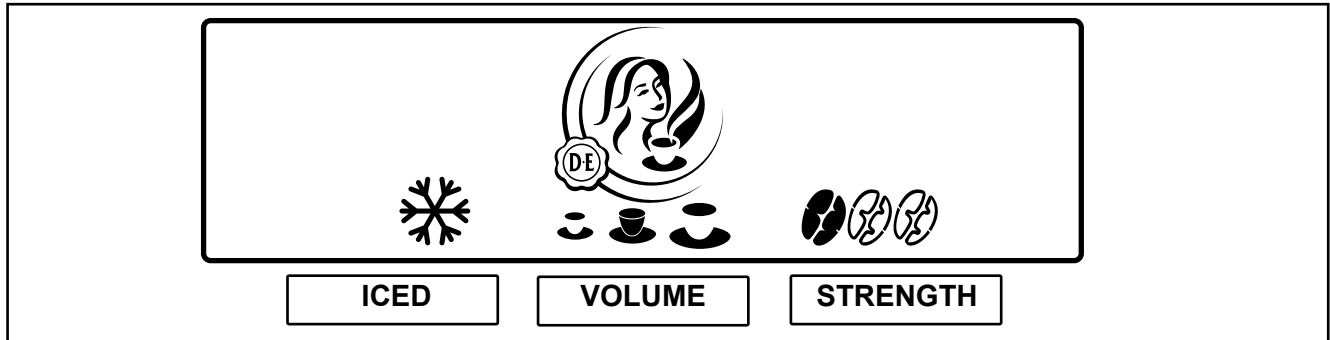

Fig. 15

Drink delivery with preselections

Your dispenser supports preselection options. The service technician may have activated these preselection options during installation. When the preselection button is pressed, the following preselection options are shown on the display (fig. 15):

- **ICED**-preselection (option)
- **VOLUME**-preselection (small - medium - large)
- **STRENGTH**-preselection (mild - normal - strong)

ICED-preselection (option)

1. Place your cup on the cup tray.
2. Press the preselection button «ICED» to activate this preselection. The icon for iced is displayed (fig. 15).
3. Press a drink button. The iced drink is delivered.
4. Press the STOP button to return to the default state.

VOLUME-preselection

1. Place your cup on the cup tray.
2. Press the preselection button «VOLUME» to activate this preselection. Three cup icons (small - medium - large) are displayed (fig. 15).
3. Press the preselection button until the required portion size is marked in black. The selection is cyclic.
4. Press a drink button. The drink is delivered with the selected portion size.
5. Press the STOP button to return to the default state.

I 4 OPERATING THE DISPENSER

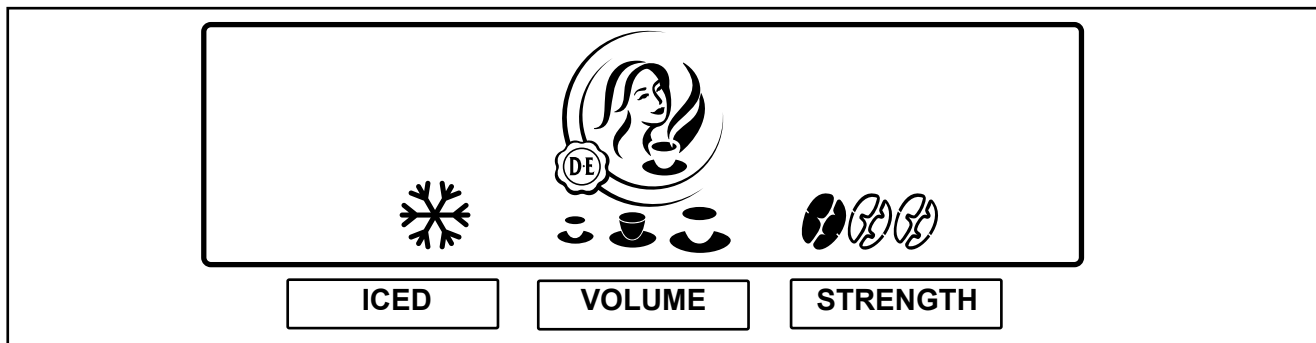

Fig. 16

STRENGTH-preselection

1. Place your cup on the cup tray.
2. Press the preselection button «STRENGTH» to activate this preselection. Three bean icons are displayed.
3. Press the preselection button until the required drink strength is marked in black (fig. 16). The selection is cyclic - (1 bean = mild, 2 beans = normal, 3 beans = strong).

4. Press a drink button. The drink will be delivered with the selected strength.
5. Press the STOP button to return to the default state.



Note:

All preselection buttons can be combined with one another.



Warning:

The liquids dispensed by the dispenser are hot! Avoid scalding! Keep hands and other body parts away from the dispenser.



Note:

If you press a preselection button, but do not press the delivery button, the dispenser will return to the default state after a few seconds.

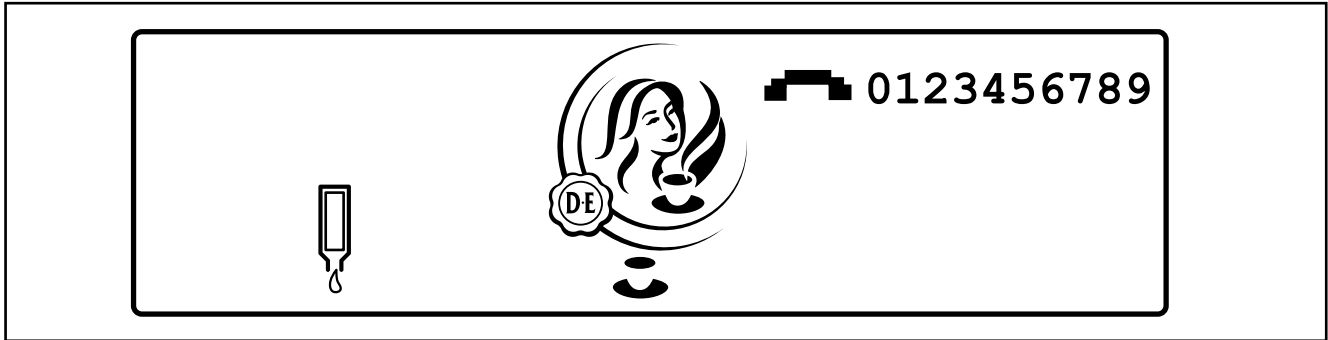

Fig. 17

Inserting and removing product packs

Empty product pack detection

If you select a drink and the corresponding product pack is empty, a drink will not be delivered. The icon for empty product pack will be shown on the display (fig. 17).

The delivery of hot or iced water is still possible.

If the operator menu «OPERATOR NR» shows the setting «SHOW OPERATOR NR» set to «YES», the entered telephone number will be shown on the display (fig. 17).

The following text will scroll in the message line:

COFFEE NOT AVAILABLE
☎ 123456789

Call the operator when necessary.



Note:

You can enter the operator number yourself via the operator menu (see „Programming the dispenser“)

I 4 OPERATING THE DISPENSER

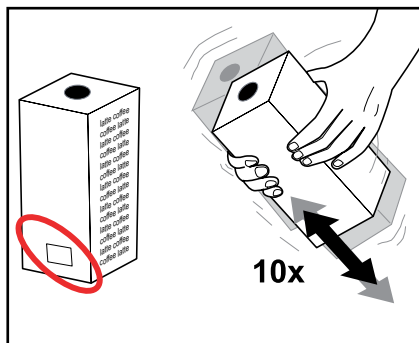

Fig. 18

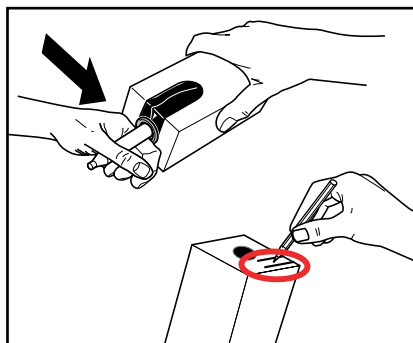

Fig. 19

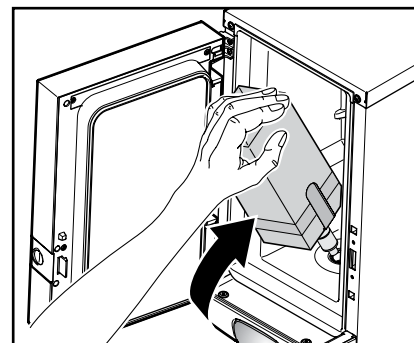

Fig. 20

Replacing an empty product pack



Caution:

Before inserting a new product pack, follow the instructions in chapter „Food safety instructions (HACCP)“.

1. Wash your hands before touching a product pack.
2. Do not use a frozen product pack.



Caution:

Read the instructions on the product pack. Never use a damaged product pack. Do not use a product pack if the „Best before“ date has expired (fig. 18).

3. Shake the product pack at least 10 times (fig. 18).
4. Remove the plastic wrapper and write the „Expiry date“ on the product pack (fig. 19).
5. Follow the instructions on the product pack to open the doser (fig. 19).

6. Open the dispenser door.
7. Insert the product pack (fig. 20).
8. Close the dispenser door.
9. Dispense a test drink.

Switching on the dispenser



Caution:

Ensure, that the dispenser is connected to the water supply.

1. Open the water tap.
2. Insert the power plug.

The dispenser starts heating up water and starts cooling down the cooling compartment. Drink delivery will be blocked until the water in the boiler has reached the correct temperature.

A flashing thermometer and the icon for „Delivery blocked“ will be shown on the display:



Note:

Depending on the dispenser model (see „Technical Specifications“) and the ambient temperature, the heating of the boiler can take between 30 and 120 minutes. The cooling of the product compartment can take 24 hours or more.



Note:

If the dispenser has been shut down for longer periods, the date and time must be set, so that the dispenser and the programmed cleaning cycles are reactivated.

Once the water has reached the preset temperature, the display shows the animated symbol illustrated below. The dispenser is now ready for operation.



Switching off the dispenser

1. Remove the product pack and check the „Expiry“ date.
- Store the product pack in a refrigerator until you switch the dispenser back on again.
- When the expiry date has passed, throw the product pack away.



Warning:

Do not freeze product packs.

2. Clean and flush the dispenser.
3. Pull the power plug out of the socket.
4. Close the water tap.

I 4 OPERATING THE DISPENSER

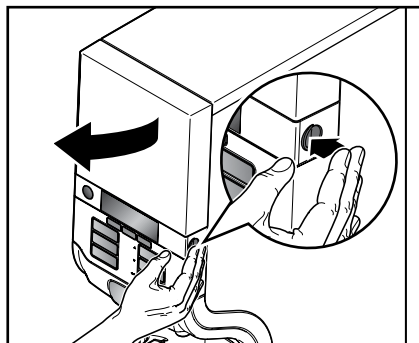

Fig. 21

Locking/unlocking the dispenser

1. Open the dispenser door (fig. 21).
2. Press the LOCK/Clear Error switch to block the drink delivery (fig. 22).

The lock icon appears on the display.



Drink delivery will be switched off. The cooling compartment and the boiler will remain in operation.

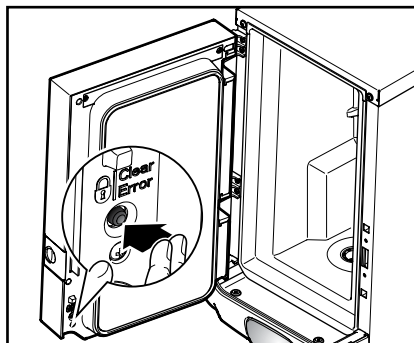

Fig. 22

3. To unlock the dispenser, press the LOCK/Clear Error switch again to enable drink delivery (fig. 22).

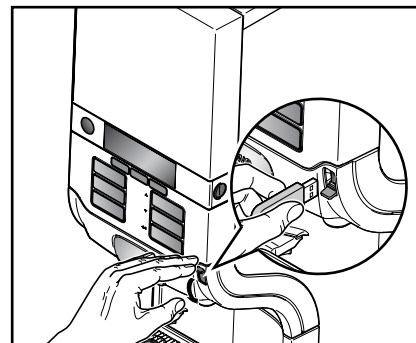

Fig. 23

Drink delivery in locked mode (option)

- Insert the USB release key into the USB port on the dispenser to enable temporary drink delivery (fig. 23).

As long as the USB release key is inserted, drinks can be delivered. When the key is removed, the locked mode is reactivated and the lock icon is shown in the display.

5 CLEANING THE DISPENSER

Cleaning procedures

It is recommended, that you clean your dispenser at regular intervals. There are two optional procedures:

- ‚Clean & Flush‘ the cooling compartment and the drink outlets.



Caution:

It is recommended to carry out the procedure ‚Clean & Flush‘ once a week.

- ‚Flush‘ the drink outlets.

When is cleaning due?

- You must clean the dispenser when the display indicates that cleaning is required.

The cleaning icon appears in the display:



Clean & Flush

The dispenser has a built-in timer that will prompt you at least one day a week to ‚Clean & Flush‘.

The service technician can enable or disable the built-in-timer according to your needs.

When the built-in-timer is enabled:

- you can select or deselect the weekday(s) for ‚Clean & Flush‘ and ‚Flush‘ procedures yourself in the operator menu «CLEANING DAYS».
- you can select one to seven days a week according to your needs.

When is cleaning overdue?

If the dispenser is not cleaned within 24 hours, the drink delivery will be blocked.

The display then shows the icon ‚delivery blocked‘:



Start the cleaning program (see next section).

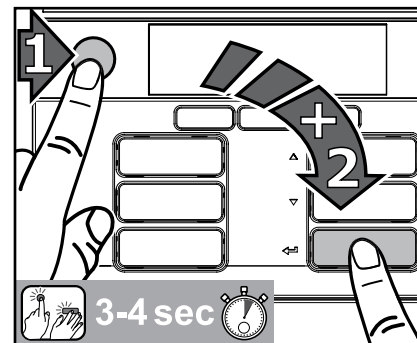



Fig. 24

Start ‚Clean & Flush‘

1. Press first the STOP button and then the enter button  and hold them pressed simultaneously for 3-4 seconds to enter the cleaning mode (fig. 24).

Follow the instructions on the display:

**PLEASE REMOVE PRODUCT
PACK**

2. Open the dispenser door.
3. Remove the product pack.

I 5 CLEANING THE DISPENSER

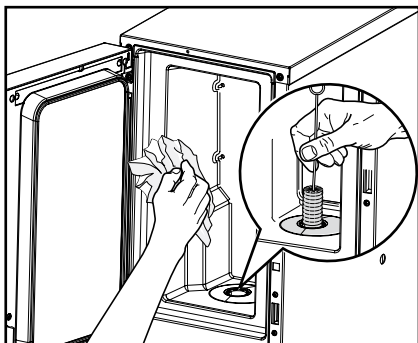

Fig. 25

The following message appears on the display:

PLEASE CLEAN THE COOLING INTERIOR AND PUT BACK THE PRODUCT PACK.



Caution:

Clean all dispenser parts that come into contact with the product with a cleaning agent. Only use cleaning agents recommended by the food industry and your Cafitesse system supplier. For safe handling, dosing and use of cleaning agents, follow the instructions on the label of the cleaning agent.

4. Clean the interior of the cooling compartment (fig. 25):
 - Use a brush wetted with cleaning agent and clean the doser hole in the bottom of the cooling compartment.
 - Dry the doser hole intensely with a clean paper towel.
 - Clean the interior of the cooling compartment thoroughly with a cloth wetted with cleaning agent.
 - Then dry the cooling compartment intensely with a clean paper towel.
5. Insert the product pack.
6. Close the dispenser door.

The following message appears on the display:

PLEASE PLACE FLUSH BIN (MIN. 4 L). PRESS ← FOR OK.



Warning:

The liquids dispensed by the dispenser are hot! Avoid scalding! Keep hands and other body parts away from the dispenser.

7. Place the flush bin under both product outlets and press the input button ←.

5 CLEANING THE DISPENSER I

Start the ‚Flush‘ procedure

1. Press first the STOP button and then the enter button  and hold them pressed simultaneously for 3-4 seconds to enter the cleaning mode.

Follow the instructions on the display (see also page 22):

**PLEASE PLACE FLUSH BIN
(MIN. 4 L). PRESS  FOR OK.**

2. Place the flush bin under both product outlets and press the enter button .

 **Warning:**
The liquids dispensed by the dispenser are hot! Avoid scalding! Keep hands and other body parts away from the dispenser.

The following message appears on the display:

PRESS  TO FLUSH

3. Press the enter button  to start the flushing process.

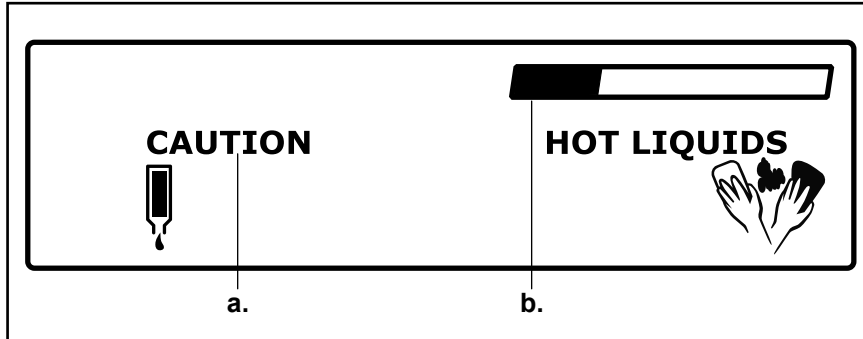



Fig. 26

The following message appears on the display:

PRESS  TO FLUSH

8. Press the enter button  to start the flushing process.

The flush process starts (fig. 26):

- a. CAUTION sign
- b. Shows the progress of flushing

After flushing is complete, the dispenser is ready for operation.

Flush

According to your own needs, you can optionally set weekdays for ‚Flush‘ in the operator menu «CLEANING DAYS».

In this case, the icon for cleaning appears on the display on the set weekday and you can then start flushing.

You can carry out the ‚Flush‘ procedure at any time you like.

I 5 CLEANING THE DISPENSER

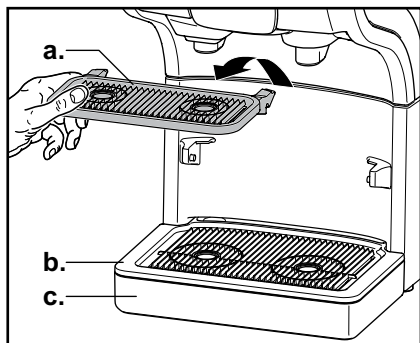

Fig. 27

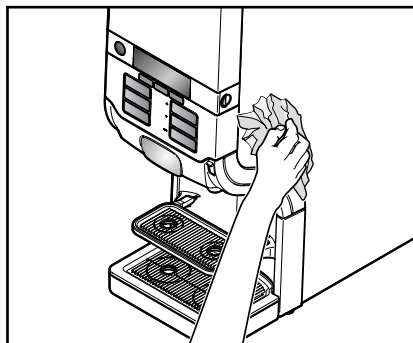

Fig. 28

Manual daily cleaning of external parts

1. Open the dispenser door and press the LOCK/Clear Error-switch to set the dispenser to locked mode.



Note:

This avoids to dispense drinks or hot water accidentally when cleaning the external parts.

2. Remove cup tray (a.), drip grid (b.), and drip tray (c.), (fig. 27)

3. Empty the drip tray.



Note:

Check and empty the drip tray at regular intervals.

4. Clean the external parts with a damp, clean cloth and rinse off with clear water.
5. Put the cup tray, drip grid and drip tray back into place.
6. Wipe down the exterior of the dispenser with a damp and clean cloth (fig. 28).



Note:

The parts can also be cleaned in a dishwasher.



Note:

Comply with the safety instructions and cleaning instructions on the cleaning agent packaging.

6 PROGRAMMING THE DISPENSER

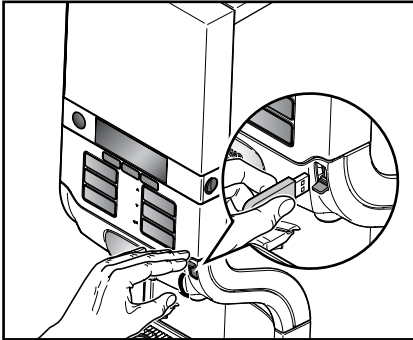

Fig. 29

Starting the operator mode

- Insert the supplied USB key into the USB port on the dispenser (fig. 29).

This immediately starts the operator mode which offers a series of functions.

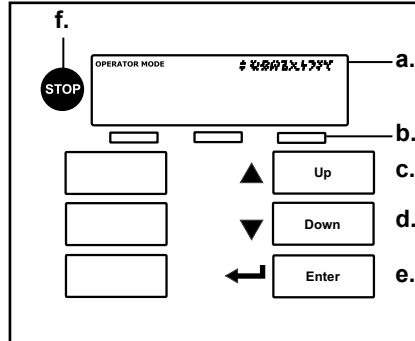

Fig. 30

Operation in the operator mode (fig. 30):

- Display**
- Three preselection buttons**
- Arrow button ,UP' ▲ -**
scroll up **or** increase input values
- Arrow button ,DOWN' ▼ -**
scroll down **or** decrease input values
- Enter button ◀ -**
for confirmation **or** activation
- STOP button -**
navigate back **or** hold down for 2 seconds to display the start menu

I 6 PROGRAMMING THE DISPENSER

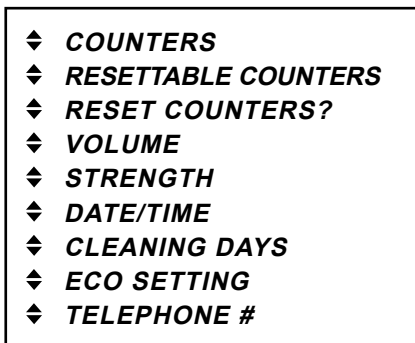

Fig. 31

Menu navigation

Nine menus are available for the operator, (fig. 31):

- **COUNTERS** - read out fixed counter levels
- **RESETTABLE COUNTERS** - read out resettable counter levels
- **RESET COUNTERS?** - set the resettable counters back to zero
- **VOLUME** - change volume per cup
- **STRENGTH** - change drink strength
- **DATE / TIME** - set time
- **CLEANING DAYS** - set weekdays for cleaning and flushing

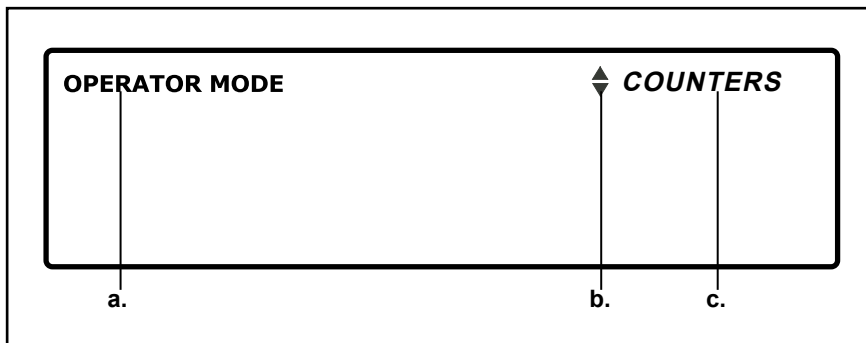

Fig. 32

- **ECO SETTINGS** - optimize power consumption
- **TELEPHONE #** - show/hide and set telephone numbers for service and operator

◆ **Note:** Certain operator menu items might be disabled by the service technician or not available for your dispenser. For more information or a menu update, contact your Cafitesse systems supplier.

When the operator mode has started, the menu «COUNTERS» is displayed in the message line (fig. 32).

- Operator mode is active.
- Arrow buttons ▼▲ can be used to activate the menus before and after the current menu.
- Display of the currently activated menu. Access the menu by pressing the enter button ↵.

When you have entered a menu, a message text on the display shows the next steps.

◆ **Note:** If the text is too long, it will scroll from left to right through the message line.

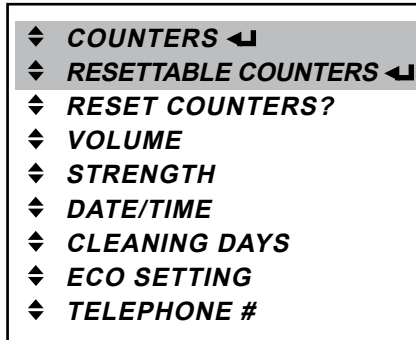

Fig. 33

Counter readings / resettable counter readings

In the «COUNTERS» menu and in the «RESETTABLE COUNTERS» menu, you have various possibilities to read out the drink counters, e.g.:

- Total number or resettable total number of drinks
- Subtotals per drink button
- Subtotals „VOLUME“ and „ICED“ per drink button
- Total number of „ICED“ and „HOT“ drinks

Both, the «COUNTERS» menu and the «RESETTABLE COUNTERS» menu function in the same way as described in this chapter.

2016 - 02

According to your needs, you can set the totals and the subtotals shown in the «RESETTABLE COUNTERS» menu back to zero, see menu «RESET COUNTERS?»

Total number of drinks or resettable total number of drinks

- In the operator mode, press the enter button to access the «COUNTERS» menu or the «RESETTABLE COUNTERS» menu (fig. 33).

On the display appears the total number of drinks

TOTAL DRINKS 1234567

or the resettable total number of drinks

RESETTABLE TOTAL DRINKS 1234567

in turn with the message

SELECT DRINK

For more detailed counter readings you can now press:

- a drink button, e.g. „coffee“ to display the counter reading of all coffee drinks

- a preselection button, e.g. „VOLUME“ to display the counter reading of all small, medium, or large drinks

Subtotals per drink button

- In the «COUNTERS» menu or the «RESETTABLE COUNTERS» menu, press a drink button, e.g. ‚coffee‘.

The number of deliveries of the selected drink button, e.g. ‚coffee‘, appears on the display.

COFFEE 543210

You now have the choice to press:

- the STOP button to go back to the higher level of the «COUNTERS» menu or the «RESETTABLE COUNTERS» menu.
- another drink button to display the respective counter reading for this button
- the preselection buttons „VOLUME“ or „ICED“ (option) for a more detailed counter readings, e.g. the number of large coffee drinks.

I 6 PROGRAMMING THE DISPENSER

Subtotals „VOLUME“ and „ICED“ (option) per drink button

1. In the «COUNTERS» menu or in the «RESETTABLE COUNTERS» menu, press a drink button, e.g. ,coffee‘.

The number of deliveries for the selected drink button, e.g. ,coffee‘, appears on the display:

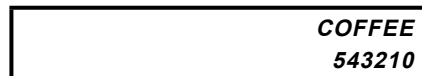

2. Press the preselection button „VOLUME“

The cup icon and the counter reading for the ,small‘ variation of the drink, e.g. small coffee, appear on the display.



-  **Note:** If you continue to press the preselection button „VOLUME“, the display shows cyclic counter readings for the middle, large, total, and small drinks.

3. Press the preselection button „ICED“ (only if the cold drinks option is installed)

The „ICED“ icon and the counter reading for the ,iced‘, ,small‘ variation of the drink, e.g. iced small coffee, appear on the display:



-  **Note:** If you continue to press the preselection button „ICED“, the display shows cyclic counter reading for the hot, total, and iced drinks in combination with the respective volume selection.

Or you have the choice to press:

- the STOP button to go back to the higher level of the «COUNTERS» menu or the «RESETTABLE COUNTERS» menu.
- another drink button to display the respective counter readings for this button.

Total number of iced and hot drinks (only if the cold drinks option is installed)

1. In the «COUNTERS» menu or in the «RESETTABLE COUNTERS» menu, press the preselection button „ICED“

The „ICED“ icon and the counter reading for the total number of iced drinks appear on the display:



2. Press again the preselection button „ICED“

The „HOT“ icon and the counter reading for the total number of hot drinks appear on the display:

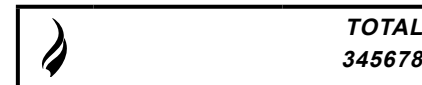

3. Press the preselection button „ICED“ again to return to the total counter reading of all drinks.

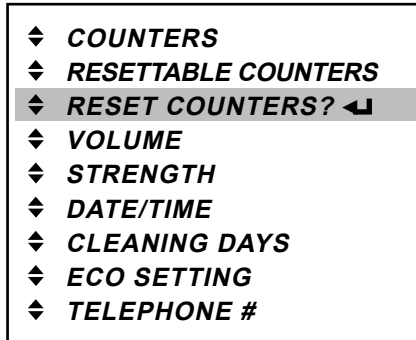

Fig. 34

Set resettable counters to zero

In the «RESET COUNTERS?» menu, you can set all resettable counter totals and subtotals to zero.

- In the operator mode, press the enter button ◀ to access the «RESET COUNTERS?» menu (fig. 34).

The message on the display instructs you to:

PRESS ◀ TO RESET COUNTERS.

You now have the choice to press:

- the STOP button to keep the current resettable counter values and to go back to the higher level of the operator menu.
- Press the enter button ◀, to set all resettable counter readings back to zero at once.

The display shows the confirmation, that all counters are reset:

COUNTERS ARE RESET.

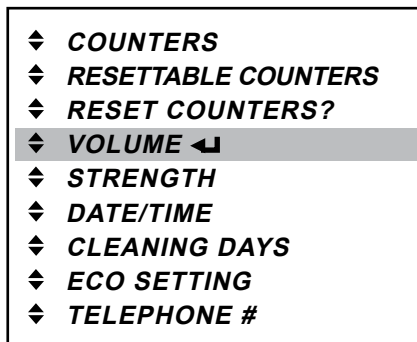

Fig. 35

Changing cup volumes

In the «VOLUME» menu, you can increase or decrease the drink volumes for all available drinks at once by up to 10%.

1. Press the enter button ◀ to access the «VOLUME» menu (fig. 35).

The following message appears on the display:

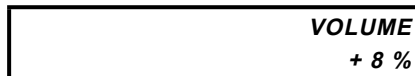

2. Increase ▲ or decrease ▼ the cup volume using the arrow buttons.
3. Confirm the required value with the enter button ◀.
The new cup volume will be accepted immediately.



Note:

If you would like to modify the drink volume again, press again the enter button ◀, and then Increase ▲ or decrease ▼.

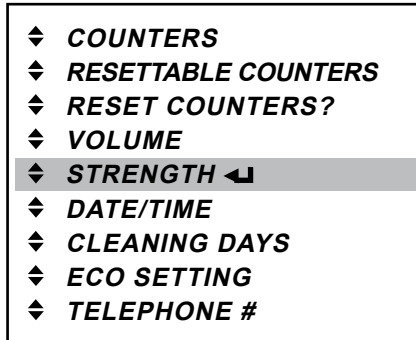

Fig. 36

Changing drink strength

In the «STRENGTH» menu, you can increase or decrease the drink strength for all available drinks at once by up to 10%.

1. Press the enter button ◀ to access the «STRENGTH» menu (fig. 36).

The following message appears on the display:

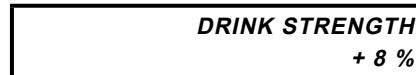

2. Increase ▲ or decrease ▼ the drink strength using the arrow buttons.
3. Confirm the required value with the enter button ◀.
 The new drink strength will be accepted immediately.



Note:

If you would like to modify the drink strength again, press again the enter button ◀, and then Increase ▲ or decrease ▼.

I 6 PROGRAMMING THE DISPENSER

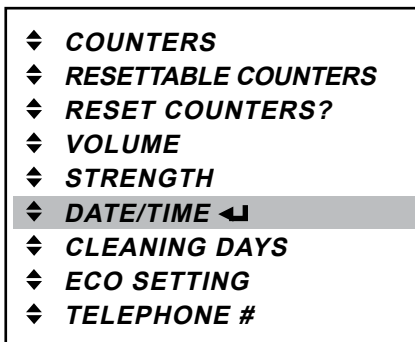

Fig. 37

Setting the date and time

You can set the date with month/day/year and time in the «DATE / TIME» menu. (The time setting needs to be adjusted at the start and end of the daylight saving time.)



Note:

If the dispenser has been shut down for longer periods, the date and time must be set, so that the dispenser and the programmed cleaning cycles are reactivated.

1. Press the enter button ◀ to access the «DATE / TIME» menu (fig. 37).

The date and time settings are shown on the display. The option «MONTH» is active and flashing:



2. Use the arrow buttons ▼▲ to select the correct month (JAN - DEC).
3. Confirm with the enter button ◀.

The option «MONTH» stays lit and the option «DAY» starts to flash:

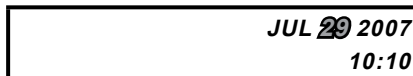

4. Use the arrow buttons ▼▲ to select the correct day (1-31).
5. Confirm with the enter button ◀.

The option «DAY» stays lit and the option «YEAR» starts to flash:

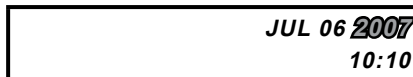

6. Use the arrow buttons ▼▲ to select the correct year.
7. Confirm with the enter button ◀.

The option «YEAR» stays lit and the option «HOUR» starts to flash:



8. Use the arrow buttons ▼▲ to select the correct hour.
9. Confirm with the enter button ◀.

The option «HOUR» stays lit and the option «MINUTES» starts to flash:

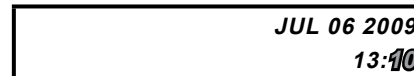

10. Use the arrow buttons ▼▲ to select the correct minutes.
11. Confirm with the enter button ◀.

After a short time, the new settings for date and time will be displayed continuously (without flashing) on the display:

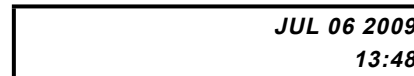

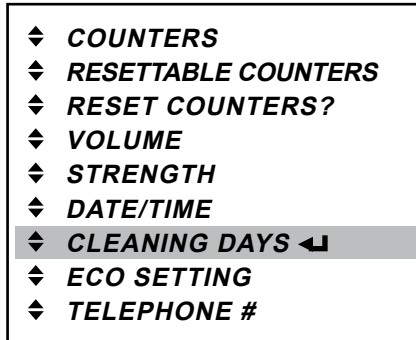

Fig. 38

Setting the cleaning days

It is recommended to clean the dispenser at least once a week. Use the «CLEANING DAYS» menu to set which weekday you want to clean or flush the dispenser.

In the «CLEANING DAYS» main menu, two sub-menus can be selected using the arrow buttons ▼▲:

- «CLEAN»
- «FLUSH»
- Press the enter button ◀ to access the «CLEANING DAYS» menu (fig. 38).

Set the day(s) for „CLEAN“

1. Use the arrow buttons ▼▲ to navigate to submenu «CLEAN».

On the display, the status icon ◻ is shown under the active weekday(s) for cleaning.

Unless you have selected another weekday for cleaning, Monday is the default setting.

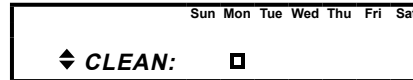

2. Press the enter button ◀ to access the «CLEAN» submenu.

The cursor icon _ is displayed, it is positioned under ‚Sun‘ (Sunday).

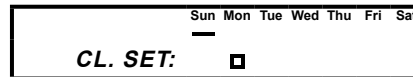

3. Use the arrow buttons ▼▲ and move the cursor icon _ to the weekday you would like to select for cleaning.
4. Press the enter button ◀ to activate the selected weekday.

The status icon ◻ appears under activated weekdays.



Note:

Several days for cleaning can be defined in sequence.



5. Select additional weekday(s) if requested by repeating steps 3. and 4.



Note:

The cleaning settings are optional.

If you would like to deactivate a weekday, which is already activated for cleaning, move the cursor icon _ to the respective weekday, and press again the enter button ◀.

I 6 PROGRAMMING THE DISPENSER

Set the day(s) for „ FLUSH“

1. Use the arrow buttons ▼▲ to navigate to submenu«FLUSH».

On the display, the status icon ■ is shown under the active weekday(s) for flushing.

Unless you have selected another weekday for flushing, Monday is the default setting.

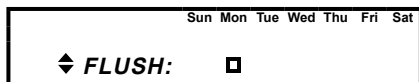

2. Press the input button ◀ to enter the «FLUSH» submenu.

The cursor icon — is displayed, it is positioned under ‚Sun‘ (Sunday).

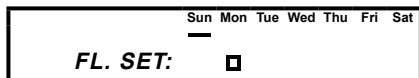

3. Use the arrow buttons ▼▲ and move the cursor icon — to the weekday you would like to select for flushing.
4. Press the enter button ◀ to activate the selected weekday.

The status icon ■ appears under activated weekdays.



Note:

Several days for flushing can be defined in sequence.

5. Select additional weekday(s) if requested by repeating steps 3. and 4.



Note:

The flushing settings are optional. If you would like to deactivate a weekday, which is already activated for flushing, move the cursor icon — to the respective weekday, and press again the enter button ◀.

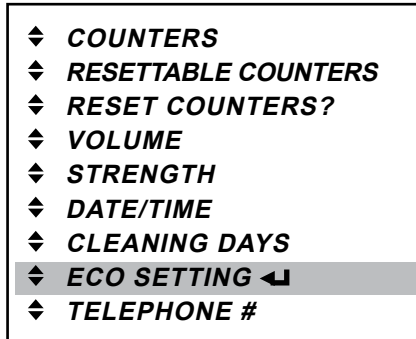

Fig. 39

ECO settings

You can optimize the power consumption of the dispenser in the menu «ECO SETTING». You can reduce the temperature of the boiler. These settings only apply to those times when the dispenser is not used (e.g. overnight). In the «ECO SETTING» menu, you can select four sub menus using the arrow buttons ▼▲:

- «ECO ENABLE/DISABLE»
- «ECO START»
- «ECO END»
- «ECO TEMPERATURE»

- Press the enter button ◀ to access the «ECO SETTING» menu (fig. 39).

Enable/disable energy saving mode (ECO)

The status (ENABLED/DISABLED) is shown on the display, e.g.:



1. Press the enter button ◀ to access the «ECO ENABLE/DISABLE» sub menu.

The status (ENABLED/DISABLED) is flashing on the display:



2. Use the arrow buttons ▼▲ to select the status «ENABLED» or «DISABLED».
3. Press the enter button ◀ to select the required status.

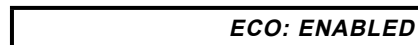

4. Press the STOP button to return to the main menu.

Setting the start time (when status: «ECO ENABLED»)

1. Use the arrow buttons ▼▲ to navigate to submenu «ECO START».

The ECO START time is shown on the display.

2. Press the enter button ◀ to access the «ECO START» sub menu.

The option „hour“ flashes and is active:

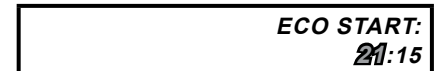

3. Use the arrow buttons ▼▲ to set the correct time (hours).
4. Confirm with the enter button ◀. The option „minutes“ flashes and is active:



5. Use the arrow buttons ▼▲ to set the correct time (minutes).
6. Confirm with the enter button ◀. The new ECO START time is shown continuously on the display.

- Press the enter button ◀ again, if you would like to restart the setting.

I 6 PROGRAMMING THE DISPENSER

Setting the start time (when status «ECO ENABLED»)

1. Use the arrow buttons ▼▲ to navigate to submenu «ECO END». The ECO END time is shown on the display.
2. Press the enter button ↵ to access the «ECO END» sub menu. The option „Hour“ flashes and is active:

ECO END:
05:55

3. Use the arrow buttons ▼▲ to select the correct time (hours).
4. Confirm with the enter button ↵. The option „minutes“ flashes and is active:

ECO END:
06:55

5. Use the arrow buttons ▼▲ to select the correct time (minutes).
6. Confirm with the enter button ↵. The new ECO END time is shown continuously on the display.
- Press the enter button ↵ again, if you would like to restart the setting.

Setting the temperature (when status «ECO ENABLED»)

1. Use the arrow buttons ▼▲ to navigate to sub menu «ECO TEMP». The ECO TEMPERATURE is shown on the display.

ECO TEMPERATURE:
63 °C / 145 °F

2. Press the enter button ↵ to access the «ECO TEMP» sub menu.

The temperature setting flashes on the display:

ECO TEMPERATURE:
63 °C / 145 °F

3. Use the arrow buttons ▼▲ to select the desired temperature.
4. Confirm with the enter button ↵.

The new temperature is shown continuously on the display, e.g.:

ECO TEMPERATURE:
75 °C / 167 °F

- Press the enter button ↵ again, if you would like to restart the setting.



Note:
When the energy saving mode is active, the «ECO» icon is shown on the display of the dispenser.

ECO

- ◆ **COUNTERS**
- ◆ **RESETTABLE COUNTERS**
- ◆ **RESET COUNTERS?**
- ◆ **VOLUME**
- ◆ **STRENGTH**
- ◆ **DATE/TIME**
- ◆ **CLEANING DAYS**
- ◆ **ECO SETTING**
- ◆ **TELEPHONE # ◀**

Fig. 40

Setting telephone numbers

You can set the telephone numbers of operator and service in the «TELEPHONE #» menu.

You can also select whether the numbers should be shown on the display. The operator and service numbers are shown, if e.g.

- cleaning is required
- the product pack is empty
- an error has occurred

In the «TELEPHONE #» main menu, four sub-menus can be selected using the arrow buttons ▼▲:

- «SHOW OPERATOR NUMBER»
 - «SHOW SERVICE NUMBER»
 - «OPERATOR NUMBER»
 - «SERVICE NUMBER»
- Press the enter button ▶ to access the «TELEPHONE #» menu (fig. 40).

The status OPERATOR NUMBER is shown on the display:

OPERATOR NR : 030123457

Activate/deactivate operator number

1. Use the arrow buttons ▼▲ to navigate to the sub menu «SHOW OPERATOR NR».
2. Press the enter button ▶ to access the sub menu.

The display shows the setting «Y» (Yes) or «N» (No), it flashes and is active, e.g.:

SHOW OPERATOR NR : N

3. Use the arrow buttons ▼▲ to select «Y» to show the number display or «N» to hide the number display.
4. Confirm with the enter button ▶.

The new setting is displayed continuously on the display, e.g.:

SHOW OPERATOR NR : Y

- Press the enter button ▶ again, if you would like to restart the setting.

I 6 PROGRAMMING THE DISPENSER

Activate/deactivate service number

1. Use the arrow buttons ▼▲ to navigate to the sub menu «SHOW SERVICE NR».
2. Press the enter button ↵ to access the sub menu.

The display show the settings «Y» (Yes) or «N» (No), it flashes and is active, e.g.:

SHOW SERVICE NR : N

3. Use the arrow buttons ▼▲ to select «Y» to show the number display or «N» to hide the number display.
4. Confirm with the enter button ↵.

The new setting is displayed continuously on the display, e.g.:

SHOW SERVICE NR : Y

- Press the enter button ↵ again, if you would like to restart the setting.

Enter the operator number

1. Use the arrow buttons ▼▲ to navigate to the sub-menu «OPERATOR NR».
2. Press the enter button ↵ to access the sub menu.

The display shows the operator telephone number. The first digit is active and flashes:

O: 0301234567



Note:
O = operator, S = service

3. Enter the first digit using the arrow buttons ▼▲.
4. Confirm with the enter button ↵.

The first digit is displayed continuously, the second digit is activated and starts flashing.

O: 501234567

5. Repeat steps 3. and 4. until you have input the last digit of the telephone number.
 6. Confirm the complete telephone number with the enter button ↵.
- Press the enter button ↵ again, if you would like to restart the setting.

Enter the service number

1. Use the arrow buttons ▼▲ to navigate to the sub-menu «SERVICE NR».
2. Press the enter button ↵ to access the sub menu.

The display shows the operator telephone number. The first digit is active and flashes:

S: 318051234567



Note:
O = operator, S = service









3. Enter the first digit using the arrow buttons ▼▲.
4. Confirm with the enter button ↵.

The first digit is displayed continuously, the second digit is activated and starts flashing.



S: 018051234567



5. Repeat steps 3. and 4. until you have input the last digit of the telephone number.
 6. Confirm the complete telephone number with the enter button ↵.
- Press the enter button ↵ again, if you would like to restart the setting.

7 DISPLAY MESSAGES AND TROUBLE SHOOTING

Display messages	Cause	Action
 0123456789   	<p>The product pack is:</p> <ul style="list-style-type: none"> • empty • incorrectly positioned • or not present 	<p>Call the operator when the number is shown on the display.</p> <ul style="list-style-type: none"> • Replace the empty product pack, see page 18. • Check whether the product pack is inserted correctly, see page 18. • Insert a product pack
	<p>The drink delivery is blocked because the dispenser was not cleaned as scheduled.</p>	<p>Start the cleaning program immediately, see page 22.</p>
  PLEASE WAIT BOILER IS HEATING UP	<p>The water in the boiler has not yet reached the preset temperature.</p>	<p>The drink delivery of the dispenser is blocked until the temperature reaches the correct value.</p>
 	<p>The drink delivery is blocked because the LOCK/Clear Error switch on the dispenser was pressed.</p>	<ul style="list-style-type: none"> • Press the LOCK/Clear Error switch again to unlock the dispenser, see page 21. • Insert the USB release key into the USB port on the dispenser for temporary enable, see page 21.

I 7 DISPLAY MESSAGES AND TROUBLE SHOOTING

Display messages	Cause	Action
	<p>The dispenser must be cleaned.</p>	<ul style="list-style-type: none"> • Call the operator when the number is shown on the display. • Start the cleaning program on the same day, see Page 22.
	<p>The drink delivery is blocked because the energy saving mode of the dispenser is switched on.</p>	<ul style="list-style-type: none"> • Press a drink button. The boiler temperature increases and the drink is dispensed as soon as the correct temperature is reached. The energy saving mode becomes active again 10 minutes after the boiler was heated up or the last drink was dispensed. • If you have set an end date, the energy saving mode ends automatically, see page 35-36.
	<p>The water filter of the dispenser must be replaced.</p>	<p>Replace the water filter.</p>

Display messages	Cause	Action
 0123456789 <i>Err 19</i>	Error water system:	Check the water supply line to the dispenser is blocked, open the water tap completely. Press the LOCK/Clear Error switch. Contact service, if the error persists.
 0123456789 <i>Err 30</i>	Errors cooling:	Check the ventilation and the ambient temperature of the dispenser, and clean the ventilation grid, if necessary. Press the LOCK/Clear Error switch. Contact service, if the error persists.
Water leaks from the hot water outlet or a product outlet.	Scale particles block the respective outlet valve, it cannot close completely.	Perform the program 'Flushing'. Contact service if the problem persists.
The dispenser does not respond to pressing a button or touch screen input.	A software jam has occurred.	Reset the dispenser: Disconnect the power supply and connect again after 5 seconds. Contact service if the problem persists.

8 TECHNICAL SPECIFICATION

Technical Specifications	Cafitesse Quantum 110
Dispenser versions	Standard version hot drinks - cup & pot delivery Café Cool version hot and cold drinks - cup & pot delivery
Dimensions	
Height	770 mm / 30.3 in.
Width	260 mm / 10.2 in.
Depth	522 mm / 20.6 in.
Weight	
empty	31.0 kg / 68.3 lbs
filled	42.0 kg / 92.6 lbs
Maximum cup/pot height	Cups: 120 mm (4.7 in) using the cup tray Pots: 213 mm (8.4 in) with cup tray folded Pots: 263 mm (10.4 in) without drip tray Air pots: 33 cm (13.4 in.) when using the optional air pot extension. („Options“)
Ingredient capacity	1 disposable Bag-in-Box (BIB) ingredient packs with a capacity of: 2 litre/0.53 gal, or 1.25 litre/0.33 gal. (Use the small optional adapters for ingredient packs („Options“))
Drink capacity	100 cups at 100 cc (3.3 fl. oz. USA) per hour per kW heating capacity
Standard water connection	1/2" or 3/8" supply line with 3/4" BSP connecting piece Drinking water line with stop valve Max. water inlet temperature 60 °C/140 °F

* see type plate, only one of the mentioned dispenser types may be available in your country

Technical Specifications	Cafitesse Quantum 110
Dynamic pressure	Min. 0.8 bar at 10 l/min - 11 psi at 2.6 USgal/min
Static pressure	Max. 10 bar - 140 psi
Boiler capacity	9 litre / 2.4 USgal
Hot water connection	Via copper pipes only
Connection water cooling unit:	Dynamic pressure: min. 0.8 bar at 1.2 l/min - 11 psi at 0.7 USgal/min
Refrigerant	0.035 kg of R134a
Electrical specification:	<ul style="list-style-type: none"> • By power cord and plug 1.80 m (70.9 in) • Direct power connection according to the Safety Instructions <p>For the connected loads refer to the rating plate. 1-phase operation Europe: max. 3.5 kW at AC 230V-240V 3-phase operation Europe: max. 9.6 kW at 3N AC 400V</p>
Environmental specifications	
Acoustic Emission	The A-weighted sound pressure level of the dispenser is below 70 dB.
Ambient Temperature for installation & operation	Between 5 °C/41 °F and 32 °C/90 °F.
Compliance	CE, VDE label (2006/42/EC machinery directive, 2004/108/EC EMC directive, 2002/72/EC food safety)

* see type plate, only one of the mentioned dispenser types may be available in your country
 The manufacturer reserves the right to change specifications without prior notice.

9 OPTIONS

The features and options listed in this section may not apply in each country. Please consult your Cafitesse system supplier for more information.

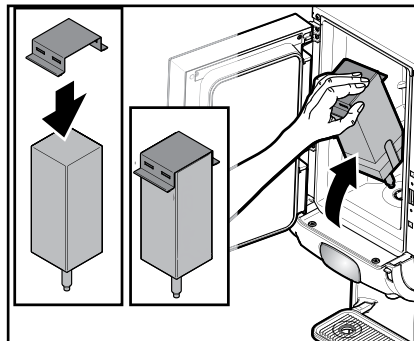

Fig. 41

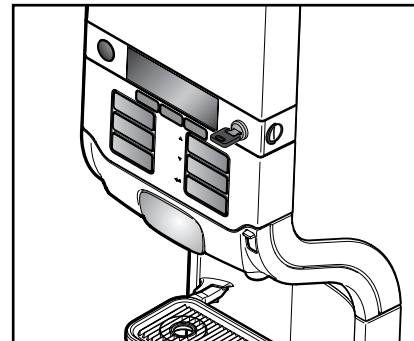

Fig. 42

Software options

On customer demand the service technician can enable or disable specific functions of your dispenser. For example:

- Alternative settings for drink recipes, varieties, strength or cup volume.
- Enable/disable preset selections such as drink strength (mild, normal, strong) or cup size (small, medium, large).
- Portioned or continuous delivery.
- Custom energy saving settings.
- Custom cleaning settings according to your preference.

Hardware accessories

Adapters for small ingredient packs

To use the dispenser with 1.25 litre/0.33 gal ingredient packs, your Cafitesse system supplier can provide special adapters for the ingredient storage to secure the packs into their position (fig. 41).

Door lock

On your request, the service technician can install a mechanical door lock in the dispenser door. In this way an unauthorized access to the dispenser can be prevented (fig. 42).

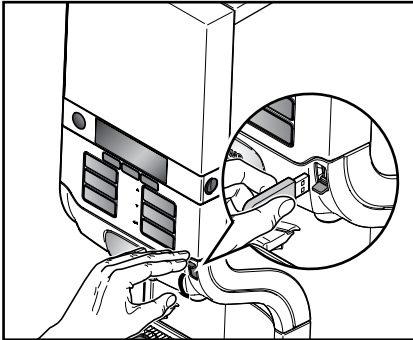

Fig. 43

USB release key

As long as you insert the USB release key into the USB port, the dispenser can temporarily deliver drinks, even if it has been switched into locked mode (fig. 43).

Air pot Extension

To allow the use of large pots like air pots, the service technician can install a special dispenser foot to increase the delivery height of the dispenser outlets to 33 cm (13.4 in.).

Payment system

If you would like to enable your dispenser for vending of drinks, the service technician can extend your dispenser with various payment systems. At your request the service technician can program specific prices per drink.

Water cooling unit

For the additional delivery of cold water and cold drinks, the service technician can equip your dispenser with a special water cooling unit.



Caution:

Test the quality of the water supply to ensure delivery of safe cold drinks according to local regulations.

10 INDEX

A

Ambient temperature, 43
Arrow button, 25

B

‚Best before‘ date, 8, 10, 18

C

Cleaning, 10, 12, 21-24, 39
Cleaning procedures, 21, 23
Cleaning days, 33-34
CLEAR/ERROR switch, 11, 20, 24, 39
Continuous delivery, 14
Cooling compartment, 11, 12, 19-22
Cooling system, 19
Counter readings, 26-28
Cup tray, 11, 13, 15, 16, 24

D

Daily cleaning, 24
Date / time, 32
Decalc, 12, 40
Dimensions, 42
Display, 11, 12
Drink delivery, 13-15, 19-21, 39-40
Drink strength, 16, 26, 31
Drink button, 11, 13
Drip grid, drip tray, 11, 24

E

ECO, 12, 26, 35-36, 40
Energy saving mode, 12, 35-36, 40
Enter button, 25
Error, 11, 40
‚Expiry‘ date, 9, 10, 18, 19

F

Filter (water filter), 12, 40
First in - First out principle, 8
Flushing, 22, 23, 33-34, 41
Front of the dispenser, 6, 12
Food safety, 4, 8, 10, 18, 21

H

HACCP, 8, 10, 18
Hot water, 4

I

ICED preselection, 12, 15, 17, 26-28
Installation, 6

M

Manual daily cleaning, 24

O

Operator mode, 12, 25-38
Operation, 4, 5, 7, 8

P

Power consumption, 35
Power cord, 6, 11,
Power supply, 19, 41
Portioned delivery, 14
Portion size, 15
Preselection, 11, 12, 15, 16, 26-28
Product pack, 4, 7-9, 12, 17-19, 39
Programming, 5-7, 17, 25

R

Rear of the dispenser, 6, 12
Refrigerator, 7, 19
Reset counters, 29
Resettable counter readings, 26-29

S

Safety instructions, 4, 5, 8, 10, 18, 24
Service mode, 12
Setting cleaning days, 33-34
Setting date / time, 32
Setting strength, 26, 31
Setting telephone number, 37-38
Setting volume, 27, 30
Storage, 7, 8
STOP button, 25
Strength preselection, 15, 16
Strength settings, 35
Switching on, 19
Switching off, 19

T

Technical specifications, 42-43
Telephone number, 17, 26, 37-38
Time settings, 32
Transport, 7, 8
Training, 10

U

USB connection, 20, 39
USB operator key, 25

V

Volume preselection, 12, 15, 27-28
Volume setting, 26, 30

W

Water supply, 6, 11, 19, 40
Weight, 42

CLEANING PROCEDURE

CLEANING (weekly)

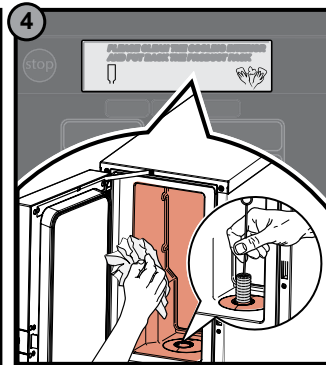
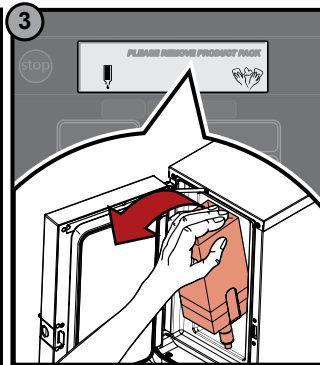
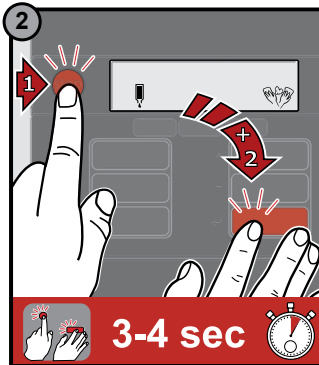
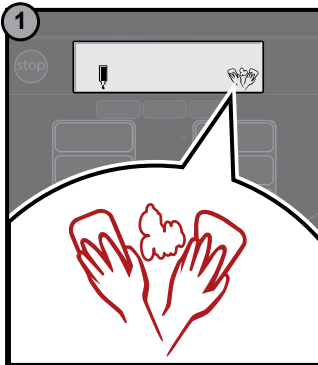

optional

FLUSHING

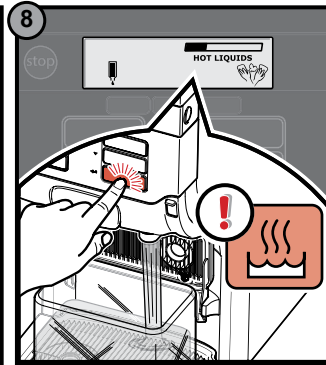
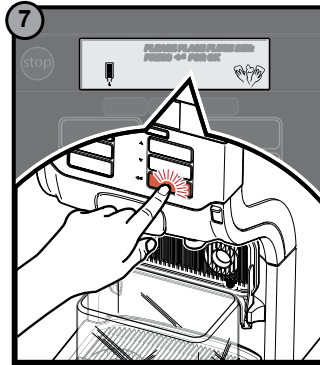
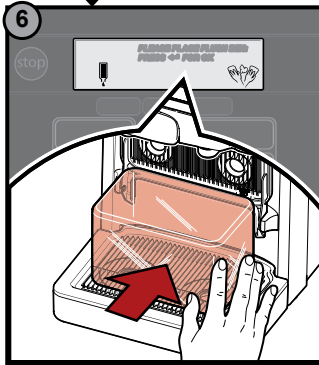
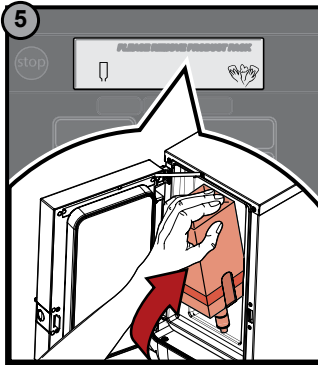

INDEX - APPENDIX

A CLEANING THE WATER TANK (OPTION)

APPENDIX A - CLEANING THE WATER TANK (OPTION)

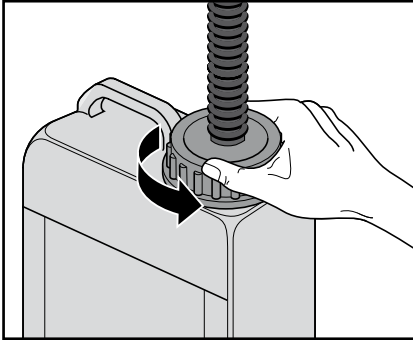

Fig. A1

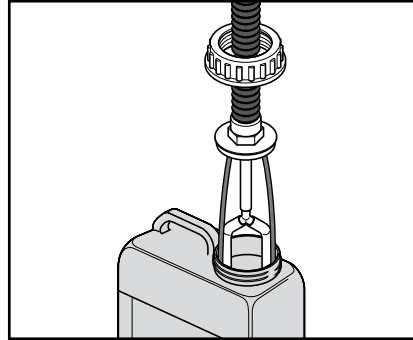

Fig. A2

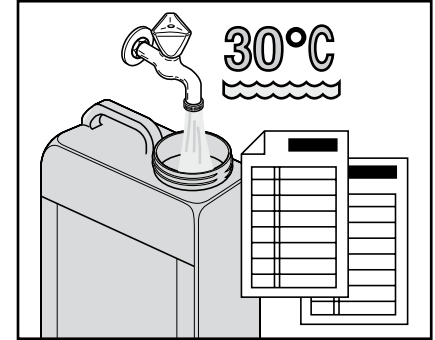

Fig. A3

Cleaning the water tank (option)



Caution:

The water tank must never be subjected directly to sunlight.



Caution:

The kit water tank must only be applied as a temporary and not as a permanent installation.



Caution:

The water tank must be filled with new drinking water every day.



Caution:

The pumps in the tank must always be covered with water.

- Pull the power plug out of the socket.
- Unscrew the closure of the water tank (fig. A1).
- Remove the pump unit (fig. A2).
- Clean the pump unit by means of a soft brush and rinse it several times.
- Empty the water tank, rinse it twice with hot drinking water and fill it with drinking water (19 l).



Caution:

Fill the tank with cold drinking water only (max. 30°C). Observe local regulations regarding the drinking water quality (fig. A3).



Note:

Make sure that the hoses are not bent.

- Insert the power plug and check the correct functioning.